

Product Catalogue
Ürün Katalođu

DISPLAY SYSTEMS

SERGİLEME
SİSTEMLERİ

 **AKDENİZ**
display systems · sergileme sistemleri



Hakkımızda

About Us



History of Akdeniz

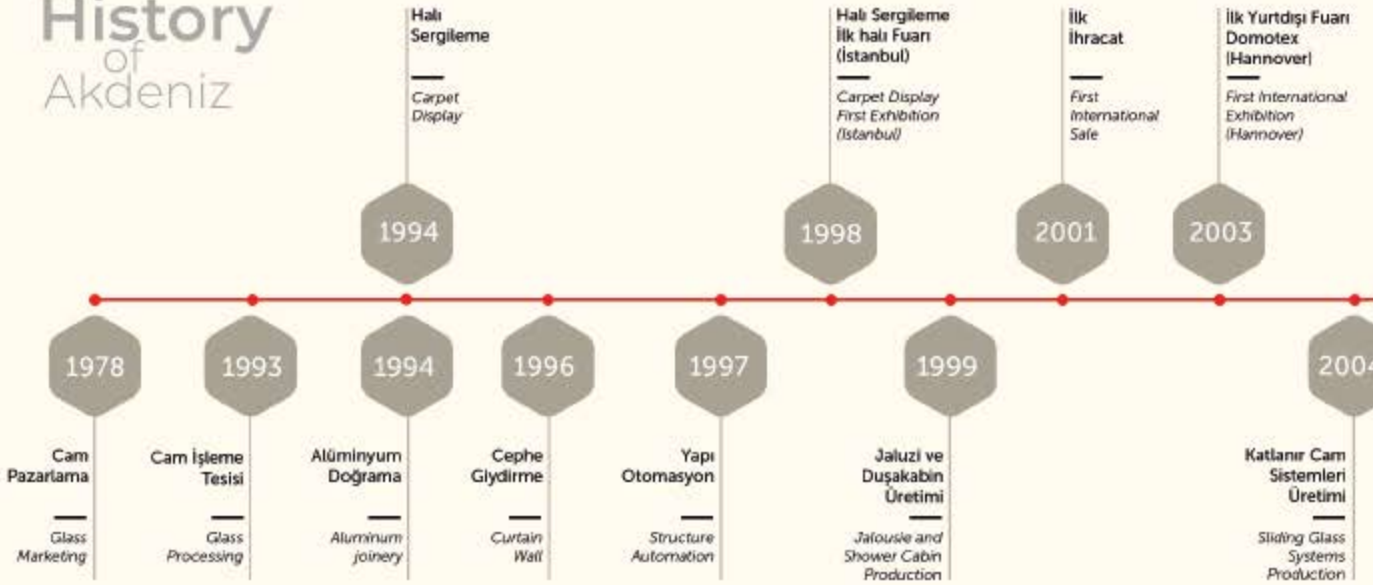

1978 yılında Konya'da Akdeniz Cam Pazarlama adı altında kurulan firmamız; yapı sektöründeki teknolojik yenilikleri ve gelişmeleri takip ederek ilerleyen yıllarda faaliyet alanına alüminyum doğrama, giydirme cephe, yapı otomasyon ve balkon camlama sistemlerini de dahil etmiştir.

Bugün, toplam 46.000 m²'lik kapalı alanda, 235 çalışanımızla beraber mutlak müşteri memnuniyeti ilkesi ve ilk günkü heyecanımızla çalışmaya devam ediyoruz.

Sergileme sistemleri üretimine 1994 yılında başlayan firmamız, şu anda parça halı, duvardan duvara halı, PVC zemin döşemeleri, yatak, parke ve seramik sektörüne hizmet etmektedir.

Müşterilerimizin önerileri doğrultusunda Ar-Ge departmanımızın yapmış olduğu çalışmalarla yeni tip sistem ve modeller geliştirmekte ve ürün gamımızı hızla arttırmaktayız.

Akdeniz A.Ş. olarak prensiplerimize ve müşteri memnuniyetine olan hassasiyetimiz ile yenilik ve hizmetlere devam edeceğiz.

Our company, Akdeniz Glass Marketing, was established in 1978 in Konya as a manufacturing and marketing company of glass products. Nowadays, our company has reached wide range of products and services such as glass, aluminium carpentry, curtain wall, building automation and glass siding systems.

Akdeniz, has started manufacturing of display systems in 1994 in a high integrated factory. Now, we are continuing our production on totally 46000 sqm closed area with our professional team with excitement to ensure customer satisfaction. Our main products for displaying are carpet display stands, rug display racks, wall to wall carpet displaying paternosters, PVC flooring displays, mattress, Parquet and ceramics displaying systems.

We are developing our products and inventing new systems in our Research and Development department with suggestions of our customers. Our main aim is to feel the real satisfaction of our customers and feel the pleasure of using our products. We are applying total quality management system and ISO 9001: 2000 Quality Management System in all processes. We claim any product with Akdeniz brand as one of the Akdeniz family and care about all the system.

We will continue to serve our customers with our creative and imaginary activities, with the power we feel from our customers.

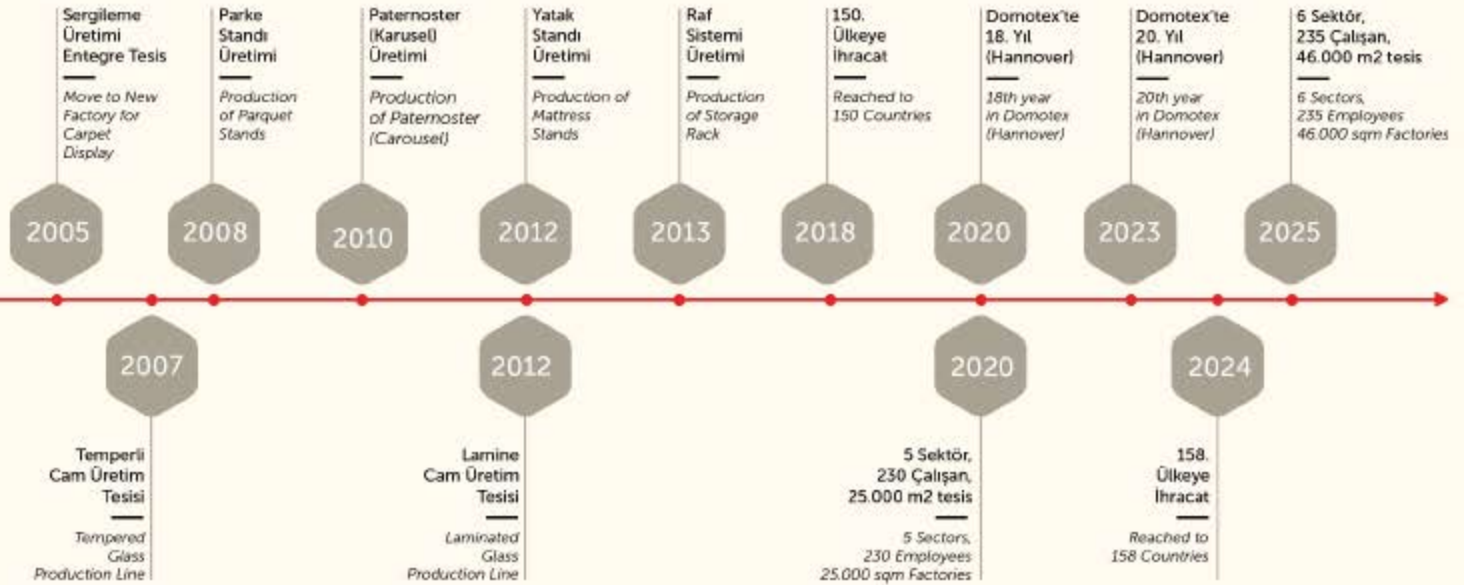



wood line
concept



içindekiler

index

- | | | | |
|----|--|----|--|
| 08 | Tavana Monte Ray Sistemi
Ceiling Fixed Rail System | 25 | Kitap Sistemi (Köşe)
Book System (for corners) |
| 10 | Eko Ray Sistemi
Eco Rail System | 26 | Multi Eko Kitap Sistemi
Multi Eco Book System |
| 12 | Özel Ray Sistemi
Special Rail System | 27 | Mobil Kitap Sistemi
Mobile Book System |
| 18 | Mono Ray Sistemi
Mono Rail System | 28 | Plus Kitap Sistemi
Plus Book System |
| 20 | Çekme Kolları
Pulling Handles | 30 | Eko Room
Eco Room |
| 20 | Aydınlatma
Lighting | 31 | Room |
| 21 | Aksesuarlar
Accessories | 32 | Semazen
Auto - Rotating Panel System |
| 22 | Numune Kitap Sistemi
Sample Book System | 33 | Işıklı Pano
Lighting Wall Panel |
| 23 | Seccade Standı
Prayer Rug Stand | 34 | Pano
Wall Panel |
| 24 | Eko Kitap Sistemi
Eco Book System | 36 | Sabit Panolar
Wall Fixed Panels |

DISPLAY SYSTEMS

S E R G İ L E M E
S İ S T E M L E R İ

- | | | | |
|----|---|----|---|
| 38 | Vizyon Vitrin Standı
Vision Show Stand | 52 | Box |
| 39 | Premium Vitrin Standı
Premium Show Stand | 54 | Manuel Rulo Sistem
Manuel Roll System |
| 40 | Multi Numune Standı
Multi Sample Stand | 56 | Vinçli Rulo Sistem
Crane Roll System |
| 43 | Raylı Numune Sistemi
Rail Sample System | 60 | Paternoster |
| 44 | Eko Numune Standı
Eco Sample Stand | 64 | Paternoster Teknik Bilgiler
Paternoster Technical Details |
| 44 | Döner Numune Standı
Rotating Sample Stand | 65 | Paternoster Aksesuarları
Paternoster Accessories |
| 45 | Numune Aksesuarları
Sample Accessories | 66 | Hafif Raf Depolama Sistemi
Light Rack Storage System |
| 46 | Yer Stantları
Floor Stands | 68 | Ağır Raf
Heavy Rack |
| 50 | Eko Yolluk
Eco Runner | | |
| 51 | Paspas Stantları
Mat Stands | | |

Tavana Monte Ray Sistemi

ceiling fixed rail system

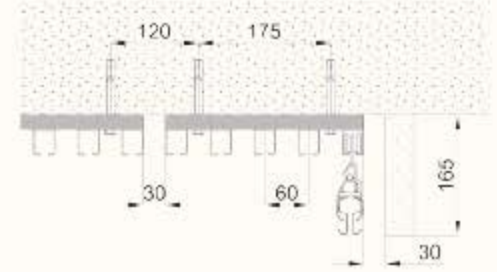
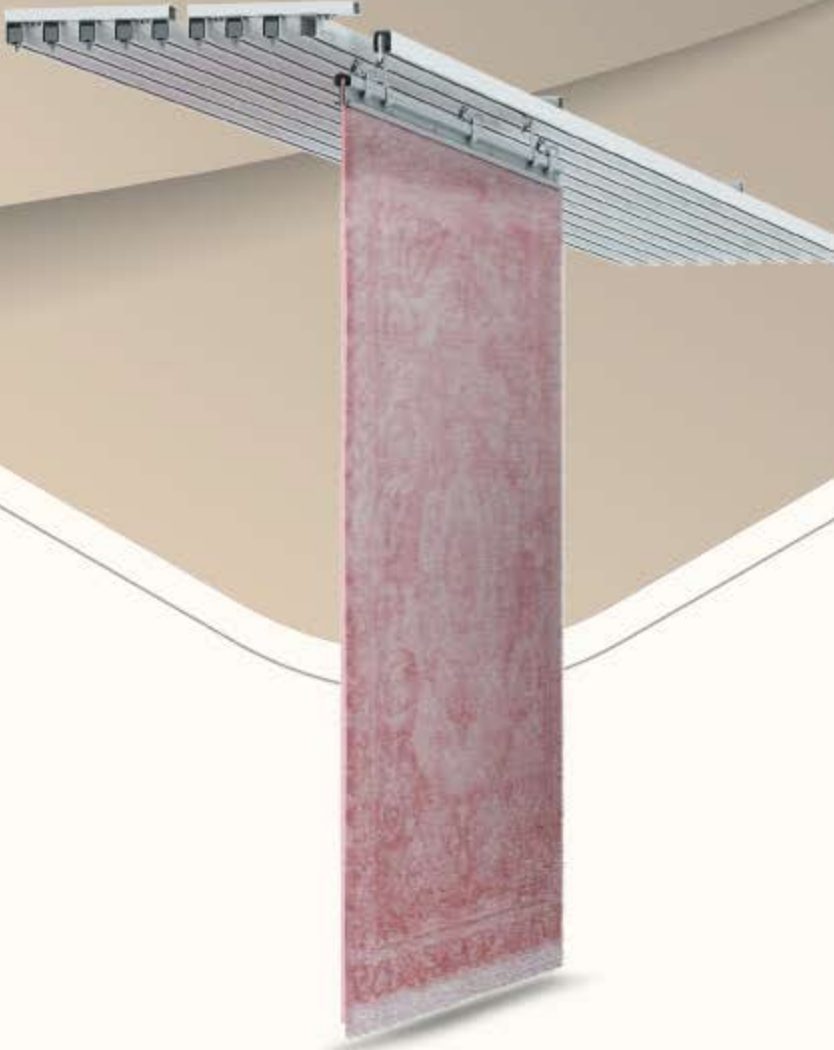

	Set Tipi Set Type	Kod Code	Ray Uzunluđu Rail Length (cm)
120 cm 125 cm	İkili / Single	AS 1201	270
	Üçlü / Double	AS 1202	386
	Dörtlü / Triad	AS 1203	525
140 cm	İkili / Single	AS 1401	300
	Üçlü / Double	AS 1402	431
	Dörtlü / Triad	AS 1403	585
150 cm	İkili / Single	AS 1501	320
	Üçlü / Double	AS 1502	461
	Dörtlü / Triad	AS 1503	625
160 cm	İkili / Single	AS 1601	340
	Üçlü / Double	AS 1602	491
	Dörtlü / Triad	AS 1603	665

	Set Tipi Set Type	Kod Code	Ray Uzunluđu Rail Length (cm)
170 cm	İkili / Single	AS 1701	360
	Üçlü / Double	AS 1702	521
	Dörtlü / Triad	AS 1703	705
200 cm	İkili / Single	AS 2001	420
	Üçlü / Double	AS 2002	611
	Dörtlü / Triad	AS 2003	825
250 cm	İkili / Single	AS 2501	520
	Üçlü / Double	AS 2502	761
	Dörtlü / Triad	AS 2503	1025
300 cm	İkili / Single	AS 3001	620
	Üçlü / Double	AS 3002	911
	Dörtlü / Triad	AS 3003	1225

1 Adet İkilü Set / A Single Set

1 Ray / 1 Rail
1 Kıskaç / 1 Clamps
2 Teker / 2 Wheels
2 Stop / 2 Stoppers

1 Adet Üçlü Set / A Double Set

1 Ray / 1 Rail
2 Kıskaç / 2 Clamps
4 Teker / 4 Wheels
2 Stop / 2 Stoppers

1 Adet Dörtlü Set / A Triad Set

1 Ray / 1 Rail
3 Kıskaç / 3 Clamps
6 Teker / 6 Wheels
2 Stop / 2 Stoppers

* 300 cm kıskaçlarda 3 adet teker kullanılmaktadır. / 3 wheels are used with 300cm length clamps

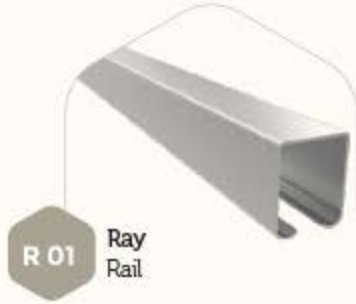
Aksesuarlar
accessoriesR 01
Ray
RailR 02
Teker
WheelR 03
Stop
StopperR 04
Montaj Profili
Montage Profile

5 li ray
gruplandırılmak için
kullanılmaktadır
5 pieces rail set
coupler



265 mm.

KLB
2004
Metal Kıskaç
Metal Clamp

Standart tüm ray
sistemlerinde
kullanılmaktadır
Used with all
standard rail systems

Kıskaç Alternatifleri
clamp alternativesKLB
2013Bantlı Kıskaç (Çivisiz)
Clamp With Tape (Without Nail)

Özel kaydırmaz bant ile deri
ve ince halıların daha kolay
sergileyecek.

With the special non-slip band
your leather and thin carpets
will be exhibited easier.

KLB
2014Max 160 cm
Borulu Kıskaç
Clamp With Tube

Yükseklik problemi olan
mağazalara alternatif
sunuyoruz.

We offer an alternative to
the stores having height
problems.

the
fundamental
solution



ER

eko ray sistemi
eco rail system



SINGLE / 2 BOJME



DOUBLE / 3 BOJME



TRIAD / 4 BOJME



	Kod Code	Kapasite Capacity	H (CM)	D (CM)	W (CM)	Kod Code	Kapasite Capacity	H (CM)	D (CM)	W (CM)	Kod Code	Kapasite Capacity	H (CM)	D (CM)	W (CM)
120X180 125X200	ER 120110	10	229	72	262	ER 120220	20	229	72	391	ER 120330	30	229	72	520
	ER 120115	15	229	102	262	ER 120230	30	229	102	391	ER 120345	45	229	102	520
	ER 120120	20	229	131	262	ER 120240	40	229	131	391	ER 120360	60	229	131	520
	ER 120125	25	229	161	262	ER 120250	50	229	161	391	ER 120375	75	229	161	520
	ER 120130	30	229	190	265	ER 120260	60	229	190	395	ER 120390	90	229	190	520
150X230	ER 150110	10	255	72	312	ER 150220	20	255	72	466	ER 150330	30	255	72	620
	ER 150115	15	255	102	312	ER 150230	30	255	102	466	ER 150345	45	255	102	620
	ER 150120	20	255	131	312	ER 150240	40	255	131	466	ER 150360	60	255	131	620
	ER 150125	25	255	161	312	ER 150250	50	255	161	466	ER 150375	75	255	161	620
	ER 150130	30	256	190	315	ER 150260	60	256	190	470	ER 150390	90	256	190	625
160X230	ER 160110	10	255	72	332	ER 160220	20	255	72	496	ER 160330	30	255	72	660
	ER 160115	15	255	102	332	ER 160230	30	255	102	496	ER 160345	45	255	102	660
	ER 160120	20	255	131	332	ER 160240	40	255	131	496	ER 160360	60	255	131	660
	ER 160125	25	255	161	332	ER 160250	50	255	161	496	ER 160375	75	255	161	660
	ER 160130	30	256	190	335	ER 160260	60	256	190	500	ER 160390	90	256	190	665
170X250	ER 170110	10	279	72	352	ER 170220	20	279	72	526	ER 170330	30	279	72	700
	ER 170115	15	279	102	352	ER 170230	30	279	102	526	ER 170345	45	279	102	700
	ER 170120	20	279	131	352	ER 170240	40	279	131	526	ER 170360	60	279	131	700
	ER 170125	25	279	161	352	ER 170250	50	279	161	526	ER 170375	75	279	161	700
	ER 170130	30	279	190	355	ER 170260	60	279	190	530	ER 170390	90	279	190	705
200X300	ER 200110	10	329	72	412	ER 200220	20	329	72	616	ER 200330	30	329	72	820
	ER 200115	15	329	102	412	ER 200230	30	329	102	616	ER 200345	45	329	102	825
	ER 200120	20	329	131	412	ER 200240	40	329	131	616	ER 200360	60	329	131	825
	ER 200125	25	329	161	412	ER 200250	50	329	161	616	ER 200375	75	329	161	825
	ER 200130	30	329	190	415	ER 200260	60	329	190	620	ER 200390	90	329	190	825
250X350	ER 250110	10	379	72	515	ER 250220	20	379	72	770	ER 250330	30	379	72	1025
	ER 250115	15	379	102	515	ER 250230	30	379	102	770	ER 250345	45	379	102	1025
	ER 250120	20	379	131	515	ER 250240	40	379	131	770	ER 250360	60	379	131	1025
	ER 250125	25	379	161	515	ER 250250	50	379	161	770	ER 250375	75	379	161	1025
	ER 250130	30	379	190	515	ER 250260	60	379	190	770	ER 250390	90	379	190	1025
300X400	ER 300110	10	429	72	615	ER 300220	20	429	72	920	ER 300330	30	429	72	1225
	ER 300115	15	429	102	615	ER 300230	30	429	102	920	ER 300345	45	429	102	1225
	ER 300120	20	429	131	615	ER 300240	40	429	131	920	ER 300360	60	429	131	1225
	ER 300125	25	429	161	615	ER 300250	50	429	161	920	ER 300375	75	429	161	1225
	ER 300130	30	429	190	615	ER 300260	60	429	190	920	ER 300390	90	429	190	1225

H: Yükseklik / Height W: Genişlik / Width D: Derinlik / Depth

sergilemede
İŞLER
RAYINDA



model 107



özel ray sistemi
special rail system

SINGLE / 2 RÖLME



DOUBLE / 3 RÖLME



TRIAD / 4 RÖLME



	Kod Code	Kapasite Capacity	H (CM)	D (CM)	W (CM)	Kod Code	Kapasite Capacity	H (CM)	D (CM)	W (CM)	Kod Code	Kapasite Capacity	H (CM)	D (CM)	W (CM)
120X180 125X200	RS 120110	10	222	79	270	RS 120220	20	222	79	386	RS 120330	30	222	79	525
	RS 120115	15	222	109	270	RS 120230	30	222	109	386	RS 120345	45	222	109	525
	RS 120120	20	222	138	270	RS 120240	40	222	138	386	RS 120360	60	222	138	525
	RS 120125	25	222	168	270	RS 120250	50	222	168	386	RS 120375	75	222	168	525
	RS 120130	30	223	198	270	RS 120260	60	223	198	386	RS 120390	90	223	198	525

150X230	RS 150110	10	255	79	320	RS 150220	20	255	79	461	RS 150330	30	255	79	625
	RS 150115	15	255	109	320	RS 150230	30	255	109	461	RS 150345	45	255	109	625
	RS 150120	20	255	138	320	RS 150240	40	255	138	461	RS 150360	60	255	138	625
	RS 150125	25	255	168	320	RS 150250	50	255	168	461	RS 150375	75	255	168	625
	RS 150130	30	256	198	320	RS 150260	60	256	198	461	RS 150390	90	256	198	625

160X230	RS 160110	10	255	79	340	RS 160220	20	255	79	491	RS 160330	30	255	79	665
	RS 160115	15	255	109	340	RS 160230	30	255	109	491	RS 160345	45	255	109	665
	RS 160120	20	255	138	340	RS 160240	40	255	138	491	RS 160360	60	255	138	665
	RS 160125	25	255	168	340	RS 160250	50	255	168	491	RS 160375	75	255	168	665
	RS 160130	30	256	198	340	RS 160260	60	256	198	491	RS 160390	90	256	198	665

170X250	RS 170110	10	272	79	360	RS 170220	20	272	79	521	RS 170330	30	272	79	705
	RS 170115	15	272	109	360	RS 170230	30	272	109	521	RS 170345	45	272	109	705
	RS 170120	20	272	138	360	RS 170240	40	272	138	521	RS 170360	60	272	138	705
	RS 170125	25	272	168	360	RS 170250	50	272	168	521	RS 170375	75	272	168	705
	RS 170130	30	273	198	360	RS 170260	60	273	198	521	RS 170390	90	273	198	705

200X300	RS 200110	10	322	79	420	RS 200220	20	322	79	611	RS 200330	30	322	79	825
	RS 200115	15	322	109	420	RS 200230	30	322	109	611	RS 200345	45	322	109	825
	RS 200120	20	322	138	420	RS 200240	40	322	138	611	RS 200360	60	322	138	825
	RS 200125	25	322	168	420	RS 200250	50	322	168	611	RS 200375	75	322	168	825
	RS 200130	30	323	198	420	RS 200260	60	323	198	611	RS 200390	90	323	198	825

250X350	RS 250110	10	373	80	520	RS 250220	20	373	80	761	RS 250330	30	373	80	1025
	RS 250115	15	373	110	520	RS 250230	30	373	110	761	RS 250345	45	373	110	1025
	RS 250120	20	373	139	520	RS 250240	40	373	139	761	RS 250360	60	373	139	1025
	RS 250125	25	373	169	520	RS 250250	50	373	169	761	RS 250375	75	373	169	1025
	RS 250130	30	373	198	520	RS 250260	60	373	198	761	RS 250390	90	373	198	1025

300X400	RS 300110	10	423	80	620	RS 300220	20	423	80	911	RS 300330	30	423	80	1225
	RS 300115	15	423	110	620	RS 300230	30	423	110	911	RS 300345	45	423	110	1225
	RS 300120	20	423	139	620	RS 300240	40	423	139	911	RS 300360	60	423	139	1225
	RS 300125	25	423	169	620	RS 300250	50	423	169	911	RS 300375	75	423	169	1225
	RS 300130	30	423	198	620	RS 300260	60	423	198	911	RS 300390	90	423	198	1225

H: Yükseklik / Height W: Genişlik / Width D: Derinlik / Depth

Özel Ray Sistemi

special rail system

107 A



107 L



201



201 A



Özel Ray Sistemi

special rail system

207



207 L



207 K



311



Derinlik / Depth: +65 cm

mono ray sistemi ile ERGONOMİK

MNR

mono ray sistemi mono rail system -for narrow places-



	Kod Code	Kol Arms	Kapasite Capacity	H (CM)	W (CM)	D (CM)
100X200	MNR 101	10	20	235	203	120
	MNR 102	15	30	235	240	120
	MNR 103	20	40	235	278	120
120X200	MNR 121	10	20	235	223	140
	MNR 122	15	30	235	260	140
	MNR 123	20	40	235	298	140

	Kod Code	Kol Arms	Kapasite Capacity	H (CM)	W (CM)	D (CM)
150X230	MNR 151	10	20	265	253	170
	MNR 152	15	30	265	290	170
	MNR 153	20	40	265	328	170
160X230	MNR 161	10	20	265	263	180
	MNR 162	15	30	265	300	180
	MNR 163	20	40	265	338	180

H: Yükseklik / Height W: Genislik / Width D: Derinlik / Depth



M 01

Alüminyum Ray
Aluminum Rail



M 02

Özel Teker
Special Wheel



M 03

Klipsli Profil
Profile with Clips



M 04

Metal Kıskaç
Metal Clamp

Çekme Kolları

pulling handles

CK 01



CK 02



CK 03



CK 04



Aydınlatma

lighting

Ray arası Led
Aydınlatma
Led Lighting
between Rails



AR 02

5 W Led Spot
5 W Led Spot



AR 04

150 W Spot
150 W Spotlight



AR 06

Şerit Led (1 m)
Tape Led



AR 07

Tüp Led (120 cm)
Tube Led



AR 08

Ray Spot (32 W)
Rail Spot



AR 09

Monofaze Ray
Monophase Rail
(100-200-300 cm)



Aksesuarlar

accessories



B 01

Boru Ø 25 mm
Tube Ø 25 mm



AP 01

Kapalı Aparat
Close Apparatus



AP 02

Açık Aparat
Open Apparatus



KLB
2001

Profil Klipsi
Profile Clips



KLB
2002

Boru Klipsi
Tube Clips



KLB
2006

Askı Klipsi
Hanging Clips



KLB
2009

Uzun Klips
Long Clips



KLB
2003

Alüminyum Kıskaç
Aluminium Clamp



KLB
2007

Metal Kıskaç
(Boruya Asma)
Metal Clamp (For Tube)



KLB
2008

Metal Kıskaç (Profil Asma)
Metal Clamp (For Profile)



KLB
2010 A

Pleksi Klips (8x11 cm)
Label Clips



KLB
2010 B

Pleksi Klips (10x15 cm)
Label Clips

Numune Kitap Sistemi

sample book system



	Kod Code	Kol Arms	Kapasite Capacity	H (CM)	W1 (CM)	W2 (CM)	D (CM)
50X80	NKS 51	10	40	218	100	184	81
	NKS 52	15	60	218	135	219	81
	NKS 53	20	80	218	170	254	81
	NKS 54	25	100	218	205	289	81
60X90	NKS 61	10	40	228	100	184	91
	NKS 62	15	60	228	135	219	91
	NKS 63	20	80	228	170	254	91
	NKS 64	25	100	228	205	289	91

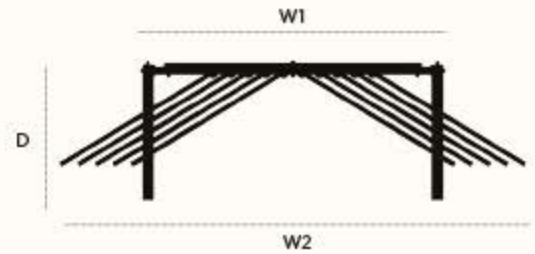

H: Yükseklik / Height W1: Kapalı Genişlik / Closed Width W2: Açık Genişlik / Opened Width D: Derinlik / Depth

Seccade Standı

prayer rug stand

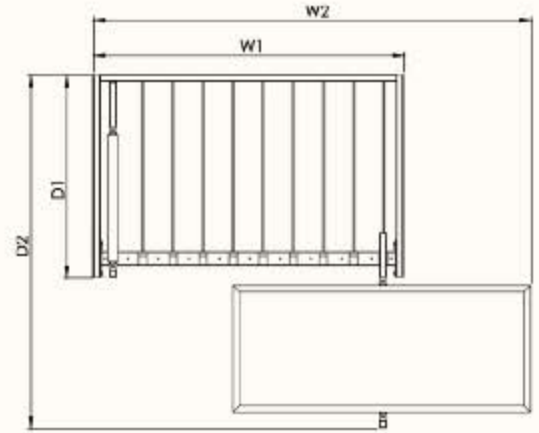

	Kod Code	Kol Arms	Kapasite Capacity	H (CM)	W1 (CM)	W2 (CM)	D1 (CM)	D2 (CM)
60X60	SNS 61	5	10	95	75	93	95	165
	SNS 62	10	20	95	140	162	95	165
	SNS 63	15	30	95	205	227	95	165
	SNS 64	20	40	95	270	292	95	165
60X80	SNS 81	5	10	115	75	103	95	165
	SNS 82	10	20	115	140	168	95	165
	SNS 83	15	30	115	205	233	95	165
	SNS 84	20	40	115	270	298	95	165

	Kod Code	Kol Arms	Kapasite Capacity	H (CM)	W1 (CM)	W2 (CM)	D1 (CM)	D2 (CM)
60X100	SNS 101	5	10	134	75	113	95	165
	SNS 102	10	20	134	140	178	95	165
	SNS 103	15	30	134	205	243	95	165
	SNS 104	20	40	134	270	308	95	165
60X120	SNS 121	5	10	153	75	123	95	165
	SNS 122	10	20	153	140	188	95	165
	SNS 123	15	30	153	205	253	95	165
	SNS 124	20	40	153	270	318	95	165

H: Yükseklik / Height W1: Kapalı Genişlik / Closed Width W2: Açık Genişlik / Opened Width D: Derinlik / Depth

Eko Kitap Sistemi

eco book system



Alınlık Opsiyonel

Derinlik / Depth: +13 cm
Yükseklik / Height: +20 cm

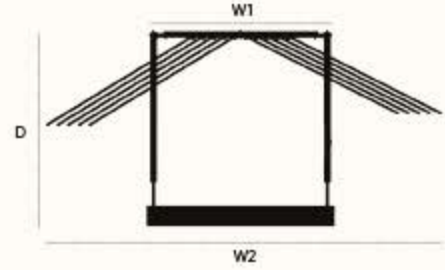

	Kod Code	Kol Arms	Kapasite Capacity	H (CM)	W1 (CM)	W2 (CM)	D (CM)
80X150	EKS 81	10	20	175	174	214	101
	EKS 82	15	30	175	209	252	101
	EKS 83	20	40	175	244	289	101
	EKS 84	25	50	175	279	327	101

	Kod Code	Kol Arms	Kapasite Capacity	H (CM)	W1 (CM)	W2 (CM)	D (CM)
150X230	EKS 151	10	20	255	174	320	171
	EKS 152	15	30	255	209	358	171
	EKS 153	20	40	255	244	396	171
	EKS 154	25	50	255	279	434	171

	Kod Code	Kol Arms	Kapasite Capacity	H (CM)	W1 (CM)	W2 (CM)	D (CM)
120X180	EKS 121	10	20	205	174	275	141
	EKS 122	15	30	205	209	313	141
	EKS 123	20	40	205	244	350	141
	EKS 124	25	50	205	279	388	141

	Kod Code	Kol Arms	Kapasite Capacity	H (CM)	W1 (CM)	W2 (CM)	D (CM)
160X230	EKS 161	10	20	255	174	338	181
	EKS 162	15	30	255	209	376	181
	EKS 163	20	40	255	244	412	181
	EKS 164	25	50	255	279	450	181

	Kod Code	Kol Arms	Kapasite Capacity	H (CM)	W1 (CM)	W2 (CM)	D (CM)
140X200	EKS 141	10	20	225	213	305	161
	EKS 142	15	30	225	248	343	161
	EKS 143	20	40	225	283	380	161
	EKS 144	25	50	225	318	418	161

	Kod Code	Kol Arms	Kapasite Capacity	H (CM)	W1 (CM)	W2 (CM)	D (CM)
170X250	EKS 171	10	20	275	174	351	191
	EKS 172	15	30	275	209	389	191
	EKS 173	20	40	275	244	427	191
	EKS 174	25	50	275	279	465	191

H: Yükseklik / Height W1: Kapalı Genişlik / Closed Width W2: Açık Genişlik / Opened Width D: Derinlik / Depth

Kitap Sistemi (Köşe)

book system (for corners)

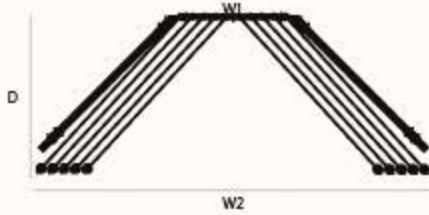

	Kod Code	Kol Arms	Kapasite Capacity	H (CM)	W1 (CM)	W2 (CM)	D (CM)
140X200	KS 141	10	20	220	96	296	166
	KS 142	15	30	220	131	331	166
	KS 143	20	40	220	166	366	166
	KS 144	25	50	220	201	401	166
150X230	KS 151	10	20	250	96	310	176
	KS 152	15	30	250	131	345	176
	KS 153	20	40	250	166	380	176
	KS 154	25	50	250	201	415	176
160X230	KS 161	10	20	250	96	324	186
	KS 162	15	30	250	131	360	186
	KS 163	20	40	250	166	394	186
	KS 164	25	50	250	201	429	186

	Kod Code	Kol Arms	Kapasite Capacity	H (CM)	W1 (CM)	W2 (CM)	D (CM)
170X250	KS 171	10	20	270	96	339	196
	KS 172	15	30	270	131	374	196
	KS 173	20	40	270	166	409	196
	KS 174	25	50	270	201	444	196
200X300	KS 201	10	20	320	96	381	226
	KS 202	15	30	320	131	416	226
	KS 203	20	40	320	166	451	226
	KS 204	25	50	320	201	486	226
250X350	KS 251	10	20	370	96	450	281
	KS 252	15	30	370	131	485	281
	KS 253	20	40	370	166	520	281
	KS 254	25	50	370	201	555	281
300X400	KS 301	10	20	420	96	521	331
	KS 302	15	30	420	131	556	331
	KS 303	20	40	420	166	591	331
	KS 304	25	50	420	201	626	331

Multi Eko Kitap Sistemi

multi eco book system

MEKS

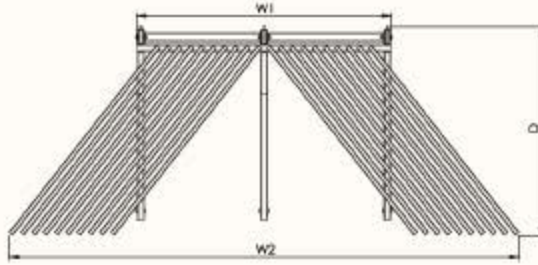

Kod Code	Kol Arms	Kapasite Capacity	H (CM)	W1 (CM)	W2 (CM)	D (CM)
-------------	-------------	----------------------	-----------	------------	------------	-----------

80X150	Kod Code	Kol Arms	Kapasite Capacity	H (CM)	W1 (CM)	W2 (CM)	D (CM)
	MEKS 81	20	40	175	139	235	100
	MEKS 82	30	60	175	200	290	100
	MEKS 83	45	90	175	293	383	100
	MEKS 84	60	120	175	385	475	100

120X180	Kod Code	Kol Arms	Kapasite Capacity	H (CM)	W1 (CM)	W2 (CM)	D (CM)
	MEKS 121	20	40	205	139	288	140
	MEKS 122	30	60	205	200	339	140
	MEKS 123	45	90	205	293	432	140
	MEKS 124	60	120	205	385	524	140

140X200	Kod Code	Kol Arms	Kapasite Capacity	H (CM)	W1 (CM)	W2 (CM)	D (CM)
	MEKS 141	20	40	225	139	315	160
	MEKS 142	30	60	225	200	364	160
	MEKS 143	45	90	225	293	457	160
	MEKS 144	60	120	225	385	549	160

Kod Code	Kol Arms	Kapasite Capacity	H (CM)	W1 (CM)	W2 (CM)	D (CM)
-------------	-------------	----------------------	-----------	------------	------------	-----------

150X230	Kod Code	Kol Arms	Kapasite Capacity	H (CM)	W1 (CM)	W2 (CM)	D (CM)
	MEKS 151	20	40	255	139	328	170
	MEKS 152	30	60	255	200	376	170
	MEKS 153	45	90	255	293	469	170
	MEKS 154	60	120	255	385	561	170

160X230	Kod Code	Kol Arms	Kapasite Capacity	H (CM)	W1 (CM)	W2 (CM)	D (CM)
	MEKS 161	20	40	255	139	340	180
	MEKS 162	30	60	255	200	388	180
	MEKS 163	45	90	255	293	481	180
	MEKS 164	60	120	255	385	573	180

170X250	Kod Code	Kol Arms	Kapasite Capacity	H (CM)	W1 (CM)	W2 (CM)	D (CM)
	MEKS 171	20	40	275	139	354	190
	MEKS 172	30	60	275	200	401	190
	MEKS 173	45	90	275	293	494	190
	MEKS 174	60	120	275	385	586	190

200X300	Kod Code	Kol Arms	Kapasite Capacity	H (CM)	W1 (CM)	W2 (CM)	D (CM)
	MEKS 201	20	40	325	139	393	220
	MEKS 202	30	60	325	200	438	220
	MEKS 203	45	90	325	293	531	220
	MEKS 204	60	120	325	385	623	220

H: Yükseklik / Height W1: Kapalı Genişlik / Closed Width W2: Açık Genişlik / Opened Width D: Derinlik / Depth

Mobil Kitap Sistemi

mobile book system

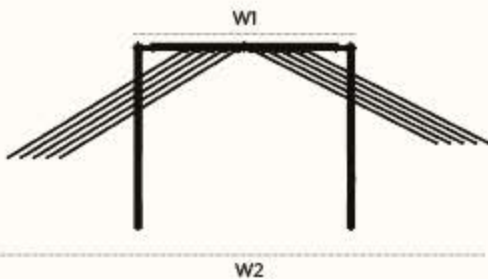

	Kod Code	Kol Arms	Kapasite Capacity	H (CM)	W1 (CM)	W2 (CM)	D (CM)
120X180	MKS 121	10	20	198	104	288	142
	MKS 122	15	30	198	139	223	142
	MKS 123	20	40	198	174	258	142
	MKS 124	25	50	198	209	393	142
150X230	MKS 151	10	20	248	104	323	172
	MKS 152	15	30	248	139	358	172
	MKS 153	20	40	248	174	393	172
	MKS 154	25	50	248	209	428	172
160X230	MKS 161	10	20	248	104	340	182
	MKS 162	15	30	248	139	375	182
	MKS 163	20	40	248	174	410	182
	MKS 164	25	50	248	209	445	182
170X250	MKS 171	10	20	268	104	358	192
	MKS 172	15	30	268	139	393	192
	MKS 173	20	40	268	174	428	192
	MKS 174	25	50	268	209	463	192
200X300	MKS 201	10	20	318	104	403	222
	MKS 202	15	30	318	139	438	222
	MKS 203	20	40	318	174	473	222
	MKS 204	25	50	318	209	508	222

H: Yükseklik / Height W1: Kapalı Genişlik / Closed Width W2: Açık Genişlik / Opened Width D: Derinlik / Depth

özel halılarınız için

- for special carpets -

PLS

plus kitap sistemi plus book system



	Kod / Code PLS One / PLS Two	Kol Arms	Kapasite Capacity	H (CM)	W1 (CM)	W2 (CM)	D (CM)
120X180	PLS-121 PLS-221	5	20	198	101	296	142
	PLS-122 PLS-222	10	40	198	176	371	142
	PLS-123 PLS-223	15	60	198	251	446	142
	PLS-124 PLS-224	20	80	198	326	521	142
150X230	PLS-151 PLS-251	5	20	248	101	351	172
	PLS-152 PLS-252	10	40	248	176	426	172
	PLS-153 PLS-253	15	60	248	251	501	172
	PLS-154 PLS-254	20	80	248	326	576	172
160X230	PLS-161 PLS-261	5	20	248	101	369	182
	PLS-162 PLS-262	10	40	248	176	444	182
	PLS-163 PLS-263	15	60	248	251	519	182
	PLS-164 PLS-264	20	80	248	326	594	182
170X250	PLS-171 PLS-271	5	20	268	101	387	192
	PLS-172 PLS-272	10	40	268	176	462	192
	PLS-173 PLS-273	15	60	268	251	537	192
	PLS-174 PLS-274	20	80	268	326	612	192



H: Yükseklik / Height W1: Kapalı Genişlik / Closed Width W2: Açık Genişlik / Opened Width D: Derinlik / Depth



Eko Room

eco room

ERS

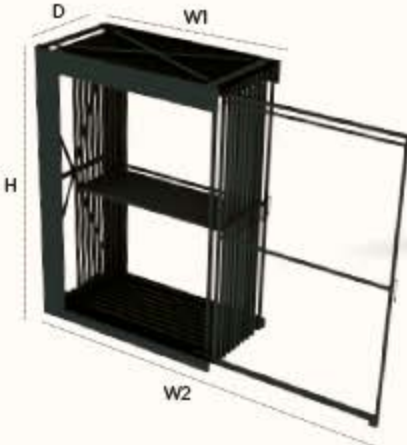

Opstyonel
Optional

	Kod Code	Kol Arms	Kapasite Capacity	H (CM)	W1 (CM)	W2 (CM)	D (CM)
120X200	ERS 121	10	20	230	150	280	118
	ERS 122	15	30	230	150	280	162
	ERS 123	20	40	230	150	280	222
150X230	ERS 151	10	20	260	175	330	118
	ERS 152	15	30	260	175	330	162
	ERS 153	20	40	260	175	330	222
160X230	ERS 161	10	20	260	185	350	118
	ERS 162	15	30	260	185	350	162
	ERS 163	20	40	260	185	350	222
170X250	ERS 171	10	20	280	195	370	118
	ERS 172	15	30	280	195	370	162
	ERS 173	20	40	280	195	370	222

H: Yükseklik / Height W1: Kapalı Genişlik / Closed Width
W2: Açık Genişlik / Opened Width D: Derinlik / Depth

Room

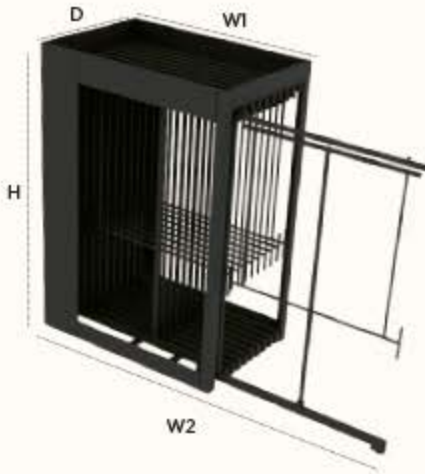

	Kod Code	Kol Arms	Kapasite Capacity	H (CM)	W1 (CM)	W2 (CM)	D (CM)
120X200	RMS 121	10	20	247	150	291	133
	RMS 122	15	30	247	150	291	188
	RMS 123	20	40	247	150	291	243
150X230	RMS 151	10	20	277	175	341	133
	RMS 152	15	30	277	175	341	188
	RMS 153	20	40	277	175	341	243
160X230	RMS 161	10	20	280	185	361	133
	RMS 162	15	30	280	185	361	188
	RMS 163	20	40	280	185	361	243
170X250	RMS 171	10	20	297	195	381	133
	RMS 172	15	30	297	195	381	188
	RMS 173	20	40	297	195	381	243

H: Yükseklik / Height W1: Kapalı Genişlik / Closed Width W2: Açık Genişlik / Opened Width D: Derinlik / Depth

Semazen

auto - rotating panel system



	Halı Ebadı Carpet Size	Kod Code	H (CM)	W (CM)	D (CM)
3S	120X180	AK 1031	225	153	186
	150X230	AK 1032	275	188	224
	160X230	AK 1033	280	198	234
	170X250	AK 1034	295	211	248
	200X300	AK 1035	345	246	278
3SL	120X180	AK 1131	295	153	186
	150X230	AK 1132	350	188	224
	160X230	AK 1133	350	198	234
	170X250	AK 1134	365	211	248
	200X300	AK 1135	415	246	278
3A	120X180	AK 1121	230	148	148
	150X230	AK 1122	285	178	178
	160X230	AK 1123	285	188	188
	170X250	AK 1124	300	198	198
	200X300	AK 1125	350	228	228

Işıklı Pano

lighting wall panel



	Kod Code	H (CM)	W (CM)	D (CM)
120X180	AK 1201 A AK 1201 L	202	150	50
150X230	AK 1202 A AK 1202 L	255	180	50
160X230	AK 1203 A AK 1203 L	255	190	50
170X250	AK 1204 A AK 1204 L	272	200	50
200X300	AK 1205 A AK 1205 L	322	230	50

H: Yükseklik / Height W: Genişlik / Width D: Derinlik / Depth

	Kod Code	H (CM)	W (CM)	D (CM)
120X180	AK 1601	200	136	100
150X230	AK 1602	255	161	100
160X230	AK 1603	255	171	100
170X250	AK 1604	270	181	100
200X300	AK 1605	320	211	100

H: Yükseklik / Height W: Genişlik / Width D: Derinlik / Depth



	Kod Code	H (CM)	W (CM)	D (CM)
120X180	AK 1901	187	128	76
150X230	AK 1902	237	158	76
160X230	AK 1903	237	168	76
170X250	AK 1904	257	178	76
200X300	AK 1905	325	208	90

H: Yükseklik / Height W: Genişlik / Width D: Derinlik / Depth

Pano

wall panel



	Halı Ebadı Carpet Size	Kod Code	H (CM)	W (CM)	D (CM)
P1	100X200	AK 1100	237	111	62
	120X180	AK 1101	217	131	62
	160X230	AK 1103	267	171	62

	Halı Ebadı Carpet Size	Kod Code	H (CM)	W (CM)	D (CM)
P3	100X200	AK 1110	200	114	75
	120X180	AK 1111	200	134	75
	160X230	AK 1113	200	174	75

	Halı Ebadı Carpet Size	Kod Code	H (CM)	W (CM)	D (CM)
P2	100X200	AK 1106	237	111	62
	120X180	AK 1107	217	131	62
	160X230	AK 1108	267	171	62

	Halı Ebadı Carpet Size	Kod Code	H (CM)	W (CM)	D (CM)
P4	100X200	AK 1116	255	115	50
	120X180	AK 1117	255	135	50
	160X230	AK 1118	255	175	50

H: Yükseklik / Height W: Genişlik / Width D: Derinlik / Depth

Pano wall panel

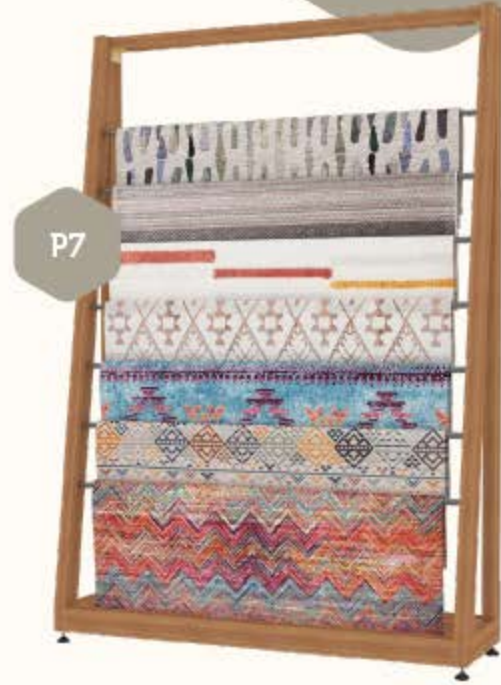

03
vitrin stantları
show stands

	Hali Ebadı Carpet Size	Kod Code	H (CM)	W (CM)	D (CM)
P5	1. 100x200 2. 120x180 3. 160x230	AK 1119	155	160	40

P6	1. 120x180 2. 160x230 3. 160x230	AK 1120	255	185	50
----	--	---------	-----	-----	----

	Hali Ebadı Carpet Size	Kod Code	H (CM)	W (CM)	D (CM)
P7	100X200	AK 1121	255	115	50
	120X180	AK 1122	255	135	50
	160X230	AK 1123	255	175	50

P8	100 cm	AK 1125	140	115	50
	150 cm	AK 1126	170	165	50

Sabit Panolar

wall fixed panels



110



110 A



110 L



210



210 A



210 B

		Kod Code	H (CM)	W (CM)	D (CM)
110	120X180	AKS 11012	22	120	25
	150X230	AKS 11015	22	150	25
	160X230	AKS 11016	22	160	25
110 A	120X180	AKS 11112	22	120	25
	150X230	AKS 11115	22	150	25
	160X230	AKS 11116	22	160	25
110 L	120X180	AKS 11212	22	120	25
	150X230	AKS 11215	22	150	25
	160X230	AKS 11216	22	160	25

		Kod Code	H (CM)	W (CM)	D (CM)
210	120X180	WL120	255	170	30
	160X230	WL160	255	210	30
	200X300	WL200	255	250	30
210 A	120X180	WL121	255	130	30
	160X230	WL161	255	170	30
	200X300	WL201	255	210	30
210 B	120X180	WL122	255	130	30
	160X230	WL162	255	170	30
	200X300	WL202	255	210	30

H: Yükseklik / Height W: Genişlik / Width D: Derinlik / Depth

Sabit Panolar

wall fixed panels

100



100 A



Kod
Code H (CM) W (CM) D (CM)

		Kod Code	H (CM)	W (CM)	D (CM)
100	120X180	AKS 10012	211	152	16
	160X230	AKS 10016	261	192	16
	200X300	AKS 10020	331	232	16

Kod
Code H (CM) W (CM) D (CM)

		Kod Code	H (CM)	W (CM)	D (CM)
100A	120X180	AKS 10112	211	152	16
	160X230	AKS 10116	261	192	16
	200X300	AKS 10120	331	232	16

300 B



300 A



Kod
Code H (CM) W (CM) D (CM)

		Kod Code	H (CM)	W (CM)	D (CM)
300 B	120X180	MK120	255	138	50
	160X230	MK160	255	178	50
	200X300	MK200	255	218	50

Kod
Code H (CM) W (CM) D (CM)

		Kod Code	H (CM)	W (CM)	D (CM)
300 A	120X180	MK121	210	160	65
	160X230	MK161	260	200	65
	200X300	MK201	320	240	65

Vizyon Vitrin Standı

vision show stand

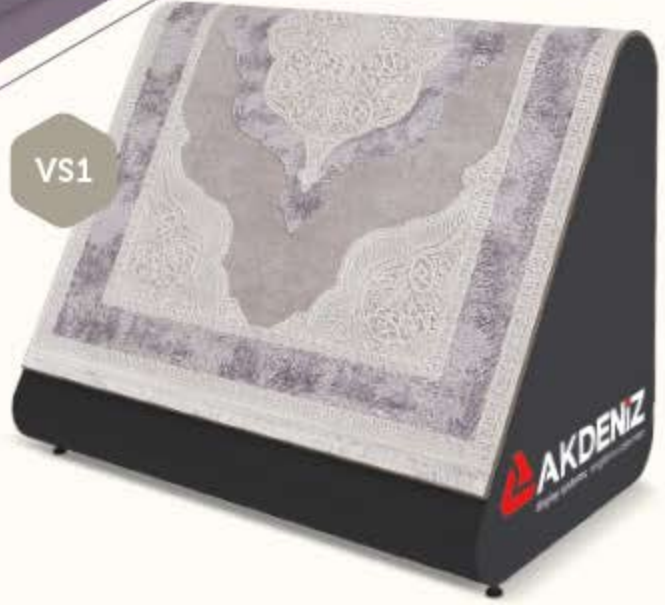

VS1



VS2



VS3

	Halı Ebadı (cm) Carpet Size (cm)	Kod Code	H (CM)	W (CM)	D (CM)
VS1	120X180	VS 1120	137	120	90
	160X230	VS 1160	137	160	90
VS2	120X180	VS 2120	116	120	50
	160X230	VS 2160	116	160	50
VS3	120X180	VS 3120	137	120	90
	160X230	VS 3160	137	160	90

H: Yükseklik / Height W: Genişlik / Width D: Derinlik / Depth

Premium Vitrin Standı

premium show stand



H: 255 cm D: 40 cm W: 170 - 200 - 250 - 300 - 350 cm
H: 320 cm D: 40 cm W: 170 - 200 - 250 - 300 - 350 cm



H: 255 cm
Ø 120 cm
Maksimum halı ebadı: 120x180 cm
Maximum carpet size: 120x180 cm



H: 21 cm

Multi Numune Standı

multi sample stand

MNS A



daha fazla alternatif
for more alternatives



Multi Numune Standı

multi sample stand



04
asistan ürünler
assistant products

	Kod Code	Bölüm Sayısı Number Of Sections	H (CM)	W (CM)	D (CM)
80 cm	MNS 81	1	255	105	50
	MNS 82	2	255	200	50
	MNS 83	3	255	295	50
100 cm	MNS 101	1	255	125	50
	MNS 102	2	255	240	50
	MNS 103	3	255	355	50
120 cm	MNS 121	1	255	145	50
	MNS 122	2	255	280	50
	MNS 123	3	255	415	50

H: Yükseklik / Height W: Genişlik / Width D: Derinlik / Depth



Multi Numune Standı

multi sample stand



	Kod Code	Bölüm Sayısı Number Of Sections	H (CM)	W (CM)	D (CM)
80 cm	MNZ 81	1	255	105	50
	MNZ 82	2	255	200	50
	MNZ 83	3	255	295	50
100 cm	MNZ 101	1	255	125	50
	MNZ 102	2	255	240	50
	MNZ 103	3	255	355	50
120 cm	MNZ 121	1	255	145	50
	MNZ 122	2	255	280	50
	MNZ 123	3	255	415	50

H: Yükseklik / Height W: Genişlik / Width D: Derinlik / Depth

Raylı Numune Sistemi

sliding sample system



SINGLE / 2 BÖLME

	Kod Code	Kol Arms	Kapasite Capacity	H (CM)	W (CM)	D (CM)
80X150	RNS 811	5	25	255	200	70
	RNS 812	10	50	255	200	130
100X200	RNS 1011	5	25	255	240	70
	RNS 1012	10	50	255	240	130
120X180	RNS 1211	5	25	255	280	70
	RNS 1212	10	50	255	280	130
160X230	RNS 1611	5	20	255	360	70
	RNS 1612	10	40	255	360	130
200X300	RNS 2011	5	15	255	440	70
	RNS 2012	10	30	255	440	130

DOUBLE / 3 BÖLME

	Kod Code	Kol Arms	Kapasite Capacity	H (CM)	W (CM)	D (CM)
80X150	RNS 821	10	50	255	300	70
	RNS 822	20	100	255	300	130
100X200	RNS 1021	10	50	255	360	70
	RNS 1022	20	100	255	360	130
120X180	RNS 1221	10	50	255	420	70
	RNS 1222	20	100	255	420	130
160X230	RNS 1621	10	40	255	540	70
	RNS 1622	20	80	255	540	130
200X300	RNS 2021	10	30	255	660	70
	RNS 2022	20	60	255	660	130

Eko Numune Standı

eco sample stand

	Halı Ebadı Carpet Size	Kod Code	H (CM)	W (CM)	D (CM)
ENS	80X150	ENS 81	255	100	15
	100X200	ENS 101	255	120	15
	120X180	ENS 121	255	140	15

H: Yükseklik / Height W: Genişlik / Width D: Derinlik / Depth

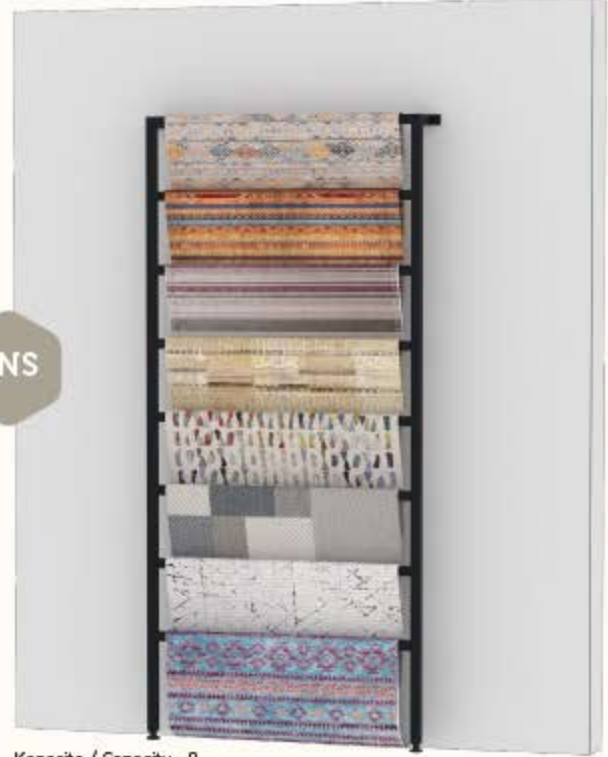

Kapasite / Capacity - 8

Döner Numune Standı

rotating sample stand



	Halı Ebadı Carpet Size	Kod Code	H (CM)	W (CM)	D (CM)
DNS	80X150	DNS 81	255	115	115
	100X200	DNS 101	255	135	135
	120X180	DNS 121	255	155	155

H: Yükseklik / Height W: Genişlik / Width D: Derinlik / Depth

Aksesuarlar

accessories

RNS K

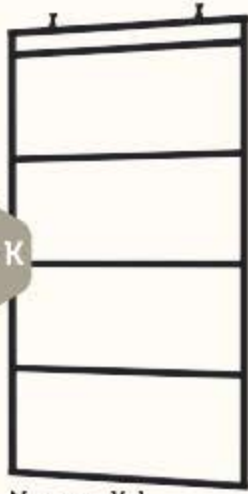

Numune Kol
Sample Holding Panel

	Halı Ebadı Carpet Size	Kod Code	Kapasite (CM)	H (CM)	W (CM)
RNS K	80X150	RNS K 81	5	149	89
	100X200	RNS K 101	5	129	109
	120X180	RNS K 121	5	137	129
	160X230	RNS K 161	4	111	169
	200X300	RNS K 201	3	85	209

H: Yükseklik / Height W: Genişlik / Width

MNS
ASA

Multi Numune Alın Sacı
Front Head Panel

ASA 81 85 cm
ASA 101 105 cm
ASA 121 125 cm

MNS
ASB

MNS Alt Sacı
MNS Bottom Panel

ASB 81 85 cm
ASB 101 105 cm
ASB 121 125 cm

MNZ
ASC

MNZ Alt Sacı
MNZ Bottom Panel

ASC 81 85 cm
ASC 101 105 cm
ASC 121 125 cm

MNS
OA

MNS Orta Ayak
MNS Middle Support Leg

MNZ
OA

MNZ Orta Ayak
MNZ Middle Support Leg

MNS
KA

MNS Kenar Ayak
MNS Side Leg

MNZ
KA

MNZ Kenar Ayak
MNZ Side Leg

MNS
B

MNS Boru
MNS Tube

B 81 90 cm
B 101 110 cm
B 121 130 cm

RST

Rustik Boru
Rustic Tube

RST 1 110 cm
RST 2 130 cm
RST 3 170 cm

Yer Stantları

floor stands



M1

Yükseklik / Height: 40 cm

Halı Ebadı (cm) Carpet Size (cm)	M1	M2
80X150	YS 101	YS 201
80X200	YS 102	YS 202
100X200	YS 103	YS 203
100X300	YS 104	YS 204
120X180	YS 105	YS 205
150X230	YS 106	YS 206
160X230	YS 107	YS 207
170X250	YS 108	YS 208
200X300	YS 109	YS 209



M2

Ön Yükseklik / Front Height: 21 cm
Arka Yükseklik / Back Height: 31 cm

Halı Ebadı (cm) Carpet Size (cm)	M3	M4
80X150	YS 301	YS 401
80X200	YS 302	YS 402
100X200	YS 303	YS 403
100X300	YS 304	YS 404
120X180	YS 305	YS 405
150X230	YS 306	YS 406
160X230	YS 307	YS 407
170X250	YS 308	YS 408
200X300	YS 309	YS 409
250X350	YS 310	YS 410
300X400	YS 311	YS 411



M3

Yükseklik / Height: 30 cm



AKS
2013
Infoboard



M4

Yükseklik / Height: 21 cm

Yer Stantları

floor stands

Halı Ebadı (cm)
Carpet Size (cm)

M5

M6

80X150	YS 501	YS 601
80X200	YS 502	YS 602
100X200	YS 503	YS 603
100X300	YS 504	YS 604
120X180	YS 505	YS 605
150X230	YS 506	YS 606
160X230	YS 507	YS 607
170X250	YS 508	YS 608
200X300	YS 509	YS 609



Yükseklik / Height: 30 cm

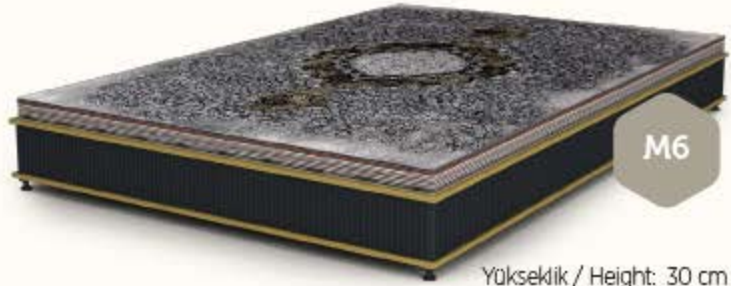

Yükseklik / Height: 30 cm



DAİRE - RAUND

Halı Ebadı (cm)
Carpet Size (cm)

Kod
Code

120 Ø	DYS 1201
160 Ø	DYS 1601
200 Ø	DYS 2001

Standart Yükseklik: 21 cm
Standard Height: 21 cm



OVAL

Halı Ebadı (cm)
Carpet Size (cm)

Kod
Code

120X180	OYS 1201
160X230	OYS 1601
200X300	OYS 2001



Standart Yükseklik: 21 cm
Standard Height: 21 cm

EL HALISI / HAND MADE CARPET

Halı Ebadı (cm)
Carpet Size (cm)

Kod
Code

60X160	EHS 1601
60x200	EHS 2001
60X250	EHS 2501
60x300	EHS 3001

Yer Stantları

floor stands



Yükseklik / Height: 21 cm

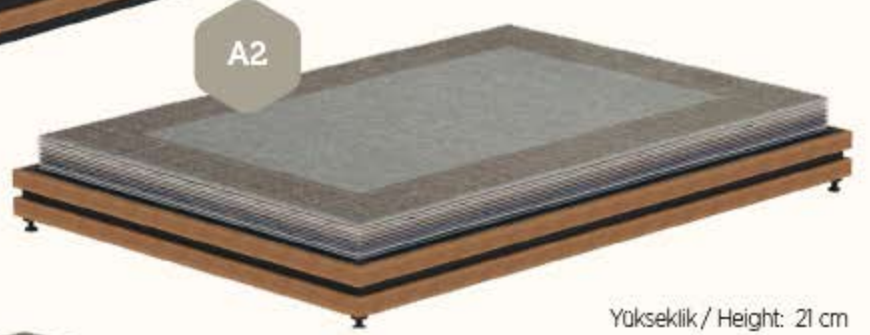

Yükseklik / Height: 21 cm



Yükseklik / Height: 30 cm



Yükseklik / Height: 30 cm

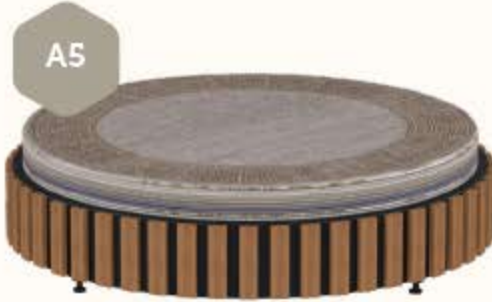

Yükseklik / Height: 30 cm



Yükseklik / Height: 30 cm

Yer Stantları floor stands



Halı Ebadı (cm)
Carpet Size (cm)

Kod
Code

80X150	KTS 101
80X200	KTS 102
100X200	KTS 103
100X300	KTS 104
120X180	KTS 105
150X230	KTS 106
160X230	KTS 107
170X250	KTS 108
200X300	KTS 109

Standart Yükseklik: 90 cm
Standard Height: 90 cm



Eko Yolluk

eco runner



EY 1



EY 2

	Yolluk Ebadı (cm) Runner Size (cm)	Kod Code	H (CM)	W (CM)	D (CM)
EY 1	80 cm	EY 81	195	98	60
	100 cm	EY 101	195	118	60
	120 cm	EY 121	195	138	60
EY 2	80 cm	EY 82	225	98	70
	100 cm	EY 102	225	118	70
	120 cm	EY 122	225	138	70

H: Yükseklik / Height W: Genişlik / Width D: Derinlik / Depth

Şelale

waterfall



W1

Halı Ebadı / Carpet Size
80X150 cm
Kapasite / Capacity - 15



W2

Halı Ebadı / Carpet Size
80X150 cm
Kapasite / Capacity - 15



W4

Halı Ebadı / Carpet Size
50X80 cm
Kapasite / Capacity - 15

Kod Code	H (CM)	W (CM)	D (CM)
W1	112	177	98
W2	102	175	98
W4	92	81	55

Paspas Stantları

mat stands

AK 311

Paspas Ebadı / Mat Size
50X80 cm
Kapasite / Capacity - 18

AK 312

Paspas Ebadı / Mat Size
50X80 cm
Kapasite / Capacity - 20

AK 313

Paspas Ebadı / Mat Size
50X80 cm
Kapasite / Capacity - 20

AK 315

Paspas Ebadı / Mat Size
40x60 cm

AK 314

Paspas Ebadı / Mat Size
50x80 cm
Kapasite / Capacity - 9

AK 316

Paspas Ebadı / Mat Size
50x80 cm

AK 317

Paspas Ebadı / Mat Size
40X60 cm

Kod Code	H (CM)	W (CM)	D (CM)
-------------	-----------	-----------	-----------

AK 311	140	120	60
--------	-----	-----	----

AK 312	140	120	60
--------	-----	-----	----

AK 313	140	120	60
--------	-----	-----	----

AK 314	140	60	60
--------	-----	----	----

AK 315	210	72	80
--------	-----	----	----

AK 316	215	92	92
--------	-----	----	----

AK 317	235	120	120
--------	-----	-----	-----

KLB
2012 A

Paspas Askısı
Mat Hanger
50 cm

KLB
2012 B

Paspas Askısı
Mat Hanger
50 cm

KLB
2012 C

Paspas Askısı
Mat Hanger
70 cm

Box

AK
601



AK
601 A



AK
604



AK
605



Kod Code	H (CM)	W (CM)	D (CM)
AK 601	75	75	75
AK 601 A	75	79	79
AK 604	60	60	60
AK 605	100	72	72



AK
607

Kod Code	H (CM)	W (CM)	D (CM)
AK 602	60	110	60
AK 602 A	60	114	62
AK 603	60	130	65
AK 607	80	160	50



AK
602



AK
602 A



AK
603

Manuel Rulo Sistem

manuel roll system

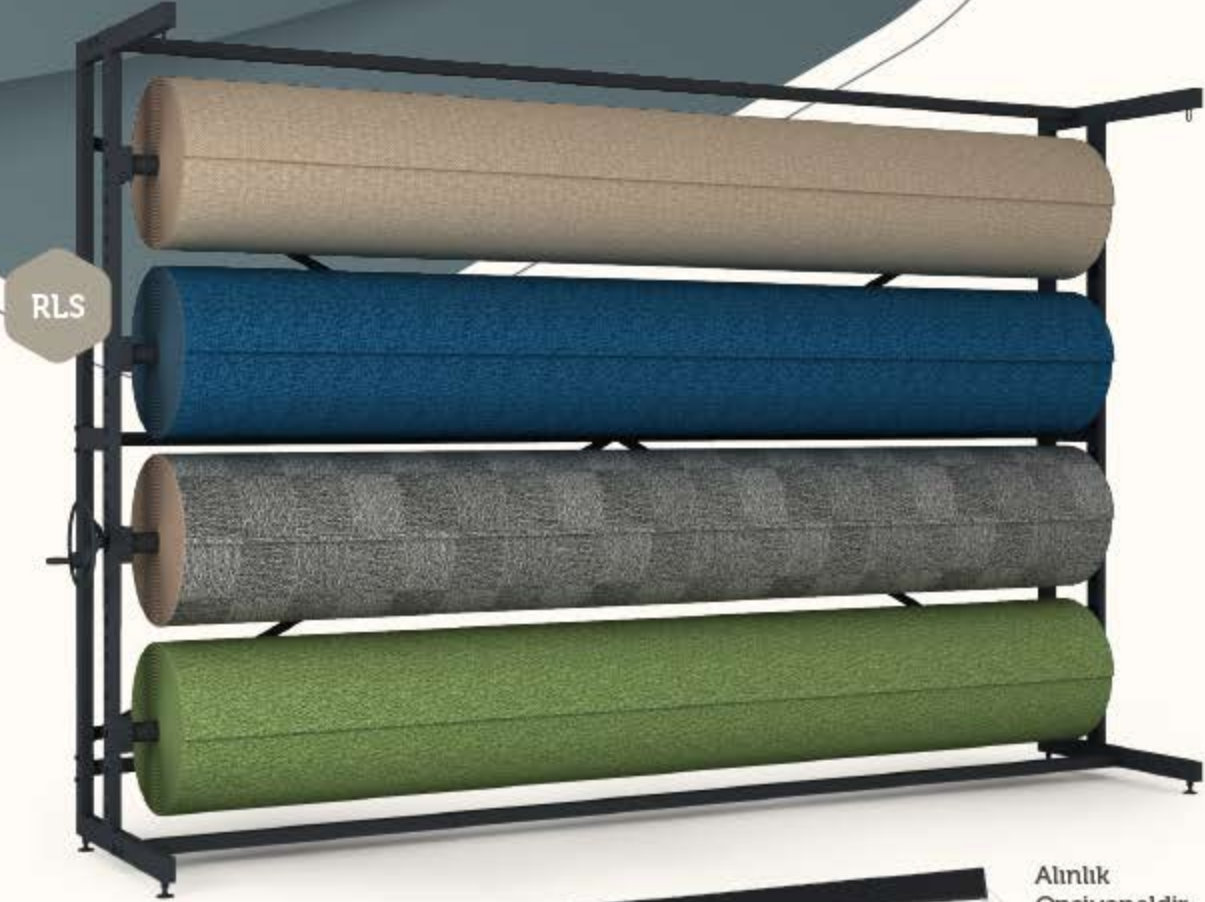

Tek Yönlü
Single Sided



Alınlık
Opsiyoneldir
Fronthead
panel is optional

TEK YÖNLÜ - SINGLE

	Kod Code	Rulo Sayısı Number Of Roll	H (CM)	W (CM)	D (CM)
400 cm	RLS 01	4	275	440	100
	RLS 02	5	340	440	120
	RLS 03	6	405	440	120
300 cm	RLS 04	4	275	340	100
	RLS 05	5	340	340	120
	RLS 06	6	405	340	120
200 cm	RLS 07	4	275	240	100
	RLS 08	5	340	240	120
	RLS 09	6	405	240	120

H: Yükseklik / Height W: Genişlik / Width D: Derinlik / Depth



RLS 101
Sarma Motoru
Rolling Motor



RLS 111
Boru Aparatı
Tube Apparatus



RLS 112
Boru Kiliti
Tube Lock



Bonular
Tubes
RLS 300 325 cm
RLS 200 225 cm
RLS 400 425 cm

Manuel Rulo Sistem

manuel roll system



RLS

Çift Yönlü
Double Sided

ÇİFT YÖNLÜ - DOUBLE

	Kod Code	Rulo Sayısı Number Of Roll	H (CM)	W (CM)	D (CM)
400 cm	RLS 13	8	285	440	172
	RLS 14	10	350	440	172
	RLS 15	12	415	440	172
300 cm	RLS 16	8	285	340	172
	RLS 17	10	350	340	172
	RLS 18	12	415	340	172
200 cm	RLS 19	8	285	240	172
	RLS 20	10	350	240	172
	RLS 21	12	415	240	172

H: Yükseklik / Height W: Genişlik / Width D: Derinlik / Depth

Alınlık
Opsiyoneldir
Fronthead
panel is optional



05
rulo sistemler
roll systems

vinçli rulo sistem ile
**İŞİN YÜKÜ
BİZDE**

ORLS

vinçli rulo sistem
crane roll system



TEK YÖNLÜ - SINGLE

	Kod Code	Rulo Sayısı Number Of Roll	H (CM)	W (CM)	D (CM)
400 cm	ORLS 01	4	298	450	110
	ORLS 02	5	363	450	120
	ORLS 03	6	428	450	120
300 cm	ORLS 04	4	298	350	110
	ORLS 05	5	363	350	120
	ORLS 06	6	428	350	120
200 cm	ORLS 07	4	298	250	110
	ORLS 08	5	363	250	120
	ORLS 09	6	428	250	120

ÇİFT YÖNLÜ - DOUBLE

	Kod Code	Rulo Sayısı Number Of Roll	H (CM)	W (CM)	D (CM)
400 cm	ORLS 13	8	308	450	220
	ORLS 14	10	373	450	240
	ORLS 15	12	438	450	240
300 cm	ORLS 16	8	308	350	220
	ORLS 17	10	373	350	240
	ORLS 18	12	438	350	240
200 cm	ORLS 19	8	308	250	220
	ORLS 20	10	373	250	240
	ORLS 21	12	438	250	240

H: Yükseklik / Height W: Genişlik / Width D: Derinlik / Depth



for
storage
and display

Paternoster



depolama ve sergileme bi'arada



Dikey hareket edebilen depolama prensibi temel alınarak, elektrikli rulo sergileme sistemleri (Paternoster) büyük ölçüde yer tasarrufu sağlayarak halı ve PVC yer döşemeleri için geliştirilmiştir.

Automatic roll systems (Paternoster), based on vertical movement, has been developed for carpets & PVC floorings and save more free space.



Paternoster

paternoster



RULO HALI - ROLL CARPET

Rulo Sayısı Number Of Rolls	Yükseklik Height (CM)	Rulo Ebadı / Roll Size		
		200 CM	300 CM	400 CM
7	270	AC 20007	AC 30007	AC 40007
8	310	AC 20008	AC 30008	AC 40008
9	350	AC 20009	AC 30009	AC 40009
10	390	AC 20010	AC 30010	AC 40010
11	430	AC 20011	AC 30011	AC 40011
12	470	AC 20012	AC 30012	AC 40012
13	510	AC 20013	AC 30013	AC 40013
14	550	AC 20014	AC 30014	AC 40014
15	590	AC 20015	AC 30015	AC 40015
16	630	AC 20016	AC 30016	AC 40016
17	670	AC 20017	AC 30017	AC 40017
18	710	AC 20018	AC 30018	AC 40018
19	750	AC 20019	AC 30019	AC 40019

Rulo çapları 60 cm'ye göre ölçülmüştür.
Default diameter is 60 cm.

RULO PVC - ROLL PVC

Rulo Sayısı Number Of Rolls	Yükseklik Height (CM)	Rulo Ebadı / Roll Size		
		200 CM	300 CM	400 CM
12	270	AP 20012	AP 30012	AP 40012
14	310	AP 20014	AP 30014	AP 40014
16	350	AP 20016	AP 30016	AP 40016
18	390	AP 20018	AP 30018	AP 40018
20	430	AP 20020	AP 30020	AP 40020
22	470	AP 20022	AP 30022	AP 40022
24	510	AP 20024	AP 30024	AP 40024
26	550	AP 20026	AP 30026	AP 40026
28	590	AP 20028	AP 30028	AP 40028
30	630	AP 20030	AP 30030	AP 40030
32	670	AP 20032	AP 30032	AP 40032
34	710	AP 20034	AP 30034	AP 40034
36	750	AP 20036	AP 30036	AP 40036

Rulo çapları 30 cm'ye göre ölçülmüştür.
Default diameter is 30 cm.

Paternoster

paternoster

DEMO1
optional



DEMO2
optional



Paternoster

paternoster



Otomatik Kesim Ünitesi

automatic cutting unit

- Hareket edebilen sistem sayesinde birden fazla ünite için tasarlanmıştır.
- Kesilecek yer döşemesi elektronik olarak ölçülebilmekte, manuel yada elektrikli makas ile kesilebilmektedir.
- Kesilen malzeme makine üzerinde dönen rulolar yardımı ile paketlenmeye hazır hale getirilebilir.

- This system is movable and designed for compatible with multi paternosters.
- Measurement is electronic, cutting is manual with an assembled automatic knife.
- Cutted parts will be re-packed by rotating rolls of cutting unit.

Kod Code	Rulo Ebadı Roll Size	H (CM)	W (CM)	D (CM)
ACT 200	200 cm	90	286	90
ACT 300	300 cm	90	386	90
ACT 400	400 cm	90	486	90



Manuel Kesim Ünitesi

manual cutting unit

- Kesme sistemi paternoster üzerine monte edilmiş şekildedir.
- Kesilecek yer döşeme uzunluğu sayaktan görünmekte, manuel olarak kesilebilmektedir.
- Tek Paternoster kullanımında tercih edilir.

- Cutting unit is fixed on Paternoster.
- Measurement is electronic, cutting is manual with a manual knife.



Kod / Code	Rulo Ebadı / Roll Size
MCT 200	200 cm
MCT 300	300 cm
MCT 400	400 cm

Otomatik Kesim Ünitesi
automatic cutting unit



Manuel Kesim Ünitesi
manuel cutting unit



Paternoster Teknik Bilgiler

paternoster technical details

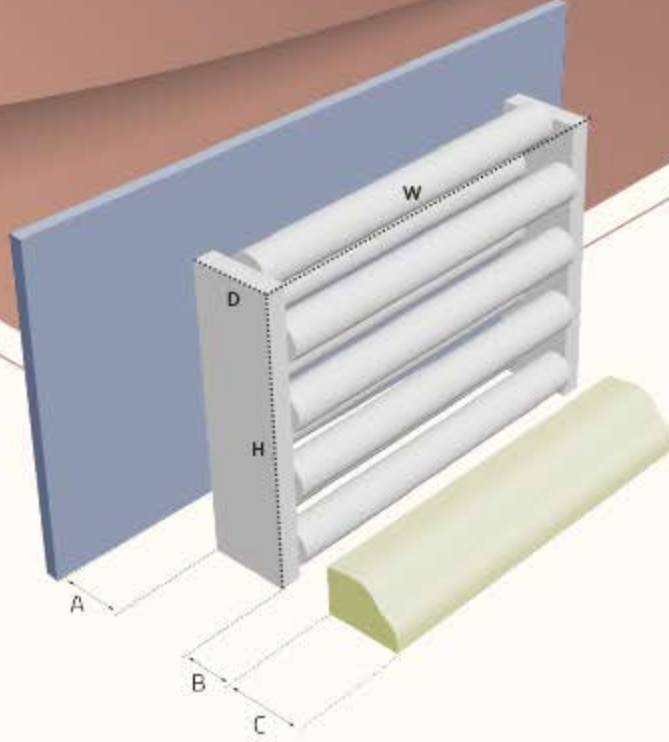

Rulo Ebadı Roll Size	H CM	W CM	D CM	A CM	B CM	C CM
200 cm	*	270	135	30	25	90
300 cm	*	370	135	30	25	90
400 cm	*	470	135	30	25	90

*H Ölçüleri yandaki tabloda detaylı olarak belirtilmiştir.
*H dimensions are stated on the table given side.

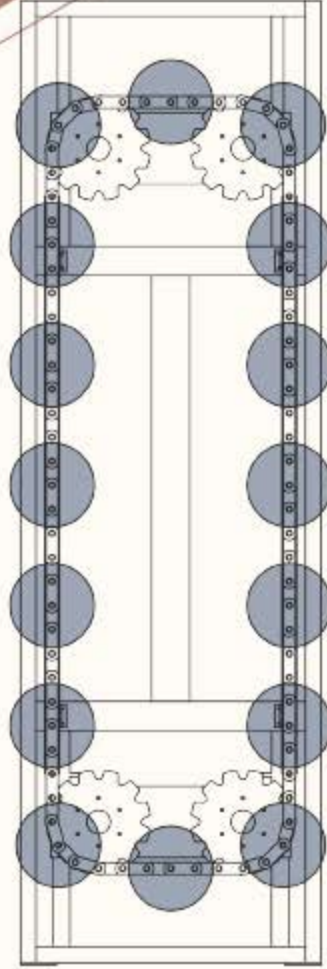

Renkler	: Standart renk: Ral 7035 Diğer renkler opsiyoneldir.
Sistem	: Elektrikli motor tahrikli, 4 adet dişli ve özel zincir
Güç	: 1,5 kw
Güç Kaynağı	: 380 V
Kontrol	: Açma, kapama ve hareket butonu
Güvenlik	: Acil stop butonu
Colours	: Standard colour: Ral 7035 Other colours are optional
System	: Electrical motor, 4 gears and special chain
Power	: 1,5 kw
Power Source	: 380 V
Control	: On,off and movement button
Security	: Emergency stop button

Yükseklik Ve Yükleme Bilgileri

height and loading details

Paternoster Yükseklik (CM) Paternoster Height (CM)	Rulo Adetleri / Rolls	
	Halı/ Carpet 400 KG. / Ø 60 CM	Pvc 200 KG. / Ø 30 CM
270	7	12
310	8	14
350	9	16
390	10	18
430	11	20
470	12	22
510	13	24
550	14	26
590	15	28
630	16	30
670	17	32
710	18	34
750	19	36

Paternoster Aksesuarları

paternoster accessories



YA
001

Yükleme Arabası
Loading Trolleys



YA
002

Yükleme Arabası
Loading Trolleys



YA
003

Sarma Arabası
Rolling Trolley



YA
004

Yükleme Arabası
Loading Trolleys



ECT
001

Elektrikli Makas
Electric Scissor



ECT
010

Yedek Bıçak
Additional Knife



BT
001

Kilitli Boru Yatağı
Tube Bearing With Lock



Borular
Tubes

Ø
70 MM

BT 02
220 cm

BT 03
320 cm

BT 04
420 cm



Borular
Tubes

Ø
114 MM

BT 12
220 cm

BT 13
320 cm

BT 14
420 cm

Alan Küçük Çözüm Büyük

hafif raf
depolama sistemi
light rack storage system



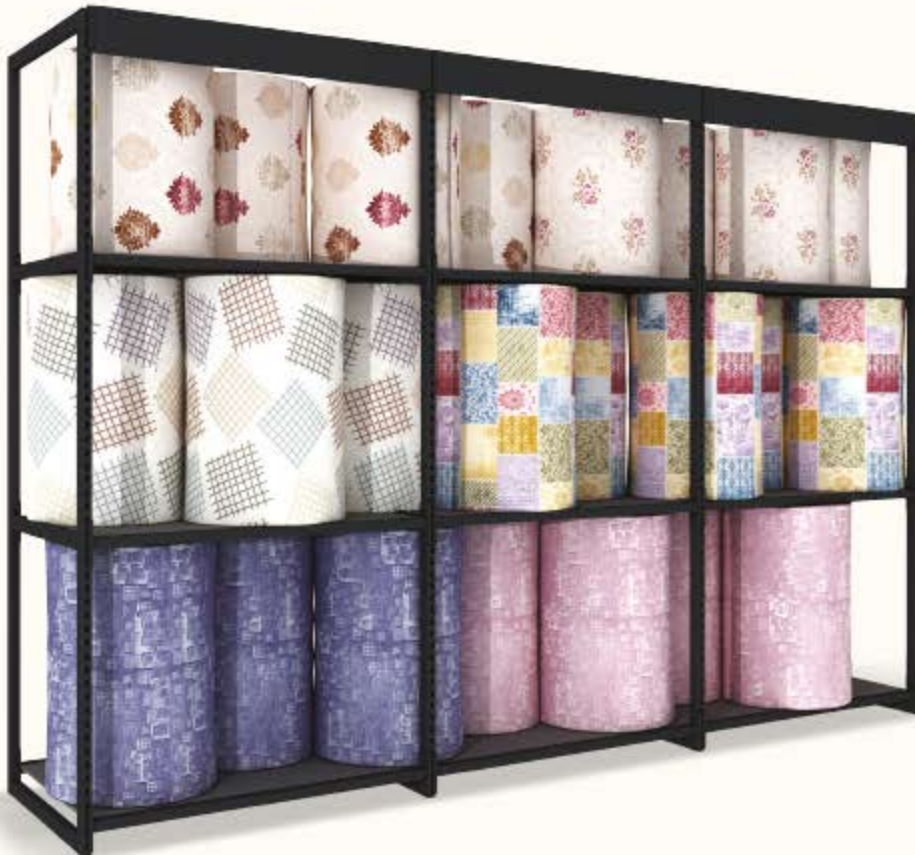
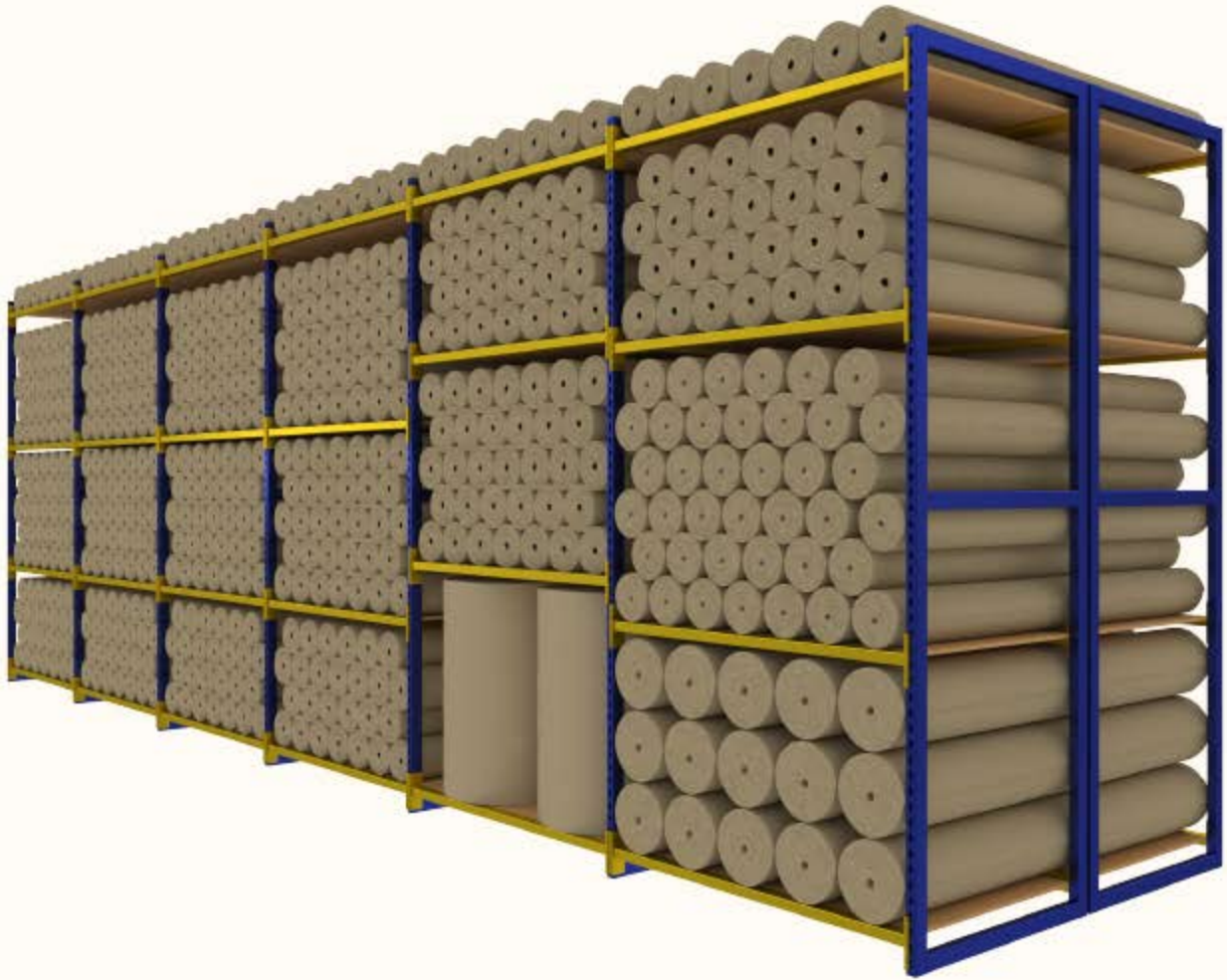

Ađır Raf

heavy rack



büyük ihtiyaçlara
sađlam alternatifler
strong alternatives for heavy needs



Ađır Raf

heavy rack

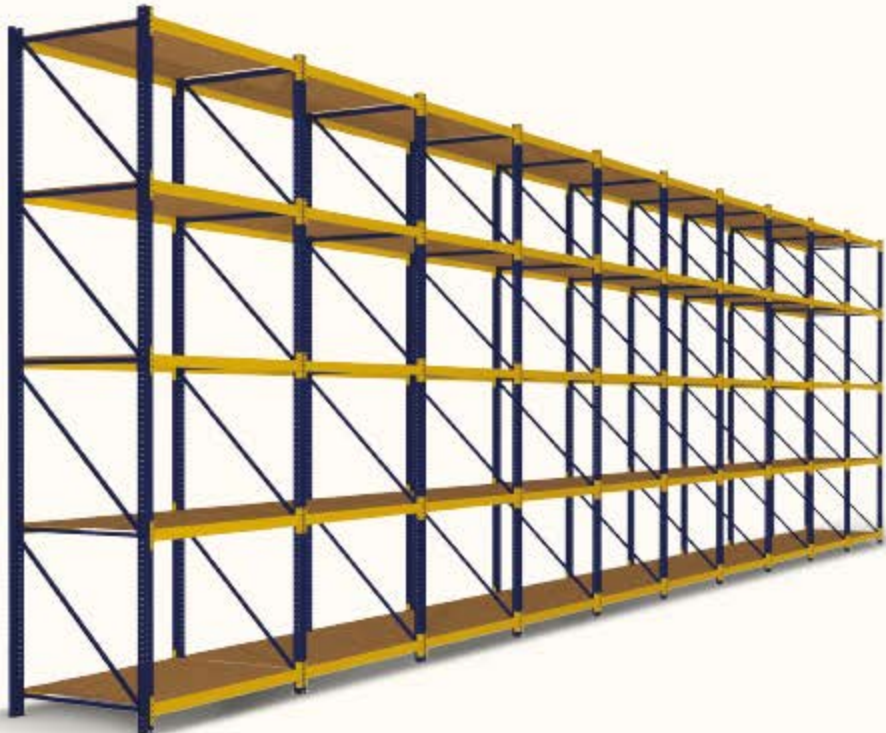

S D I S P L A Y S Y S T E M
D I S P L A Y S Y S T E M S
S D I S P L A Y S Y S T E M
D I S P L A Y S Y S T E M S

Merkez / Head Office

Büsan Organize Sanayi Kosgeb Cd.
No:29 Karatay, Konya / Türkiye

[444 10 80]

T: +90 332 236 61 66

www.akdenizdisplay.com